

ECO-KING

King Heating Products Inc.

WWW.ECOKINGHEATING.COM

ECO-KING SUPREME

Parts Breakdown





Subscribe to Eco-King on





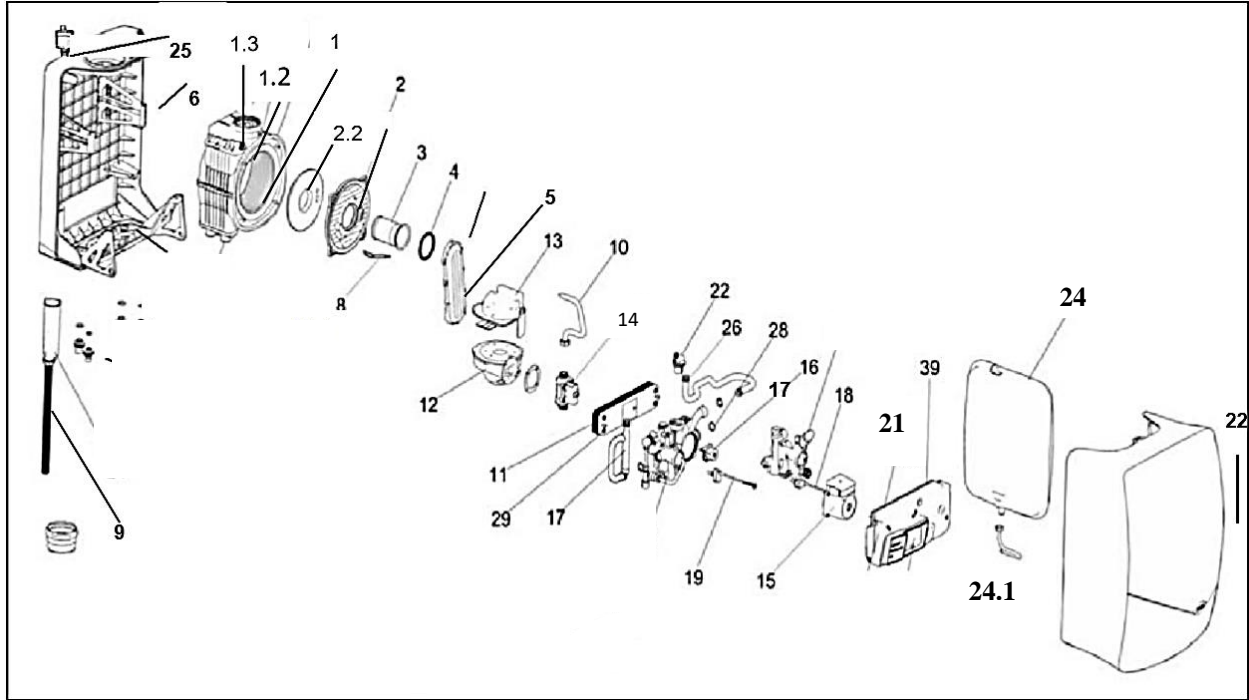

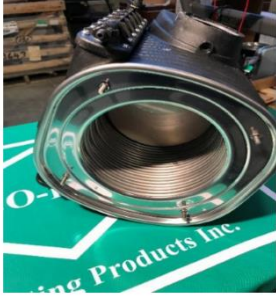



Head Office: #103, 2567 – 192 Street, Surrey BC V3Z 3X1





E: sales@ecokingheating.com P: 604.385.3265









Exploded View Number	Picture	Part Description	Eco-King Part Number
1		Heat Exchanger	EK106 - 1028 C/H 100 Model
			EK106 - 1029 C/H 140 Model
			EK106 - 1031 C/H 200 Model
1.2		Bayonet Clixon (Green Sensor)	EK106 - 1150
1.3		NTC Sensor (Blue Sensor)	EK106 - 1241
2		Burner Door	EK106-1033



2.2		Burner Door Insulation	EK106 - 1162
2.2		Burner Door	EK106 - 1033
		Burner Door Insulation	EK106 - 1162
		Burner	EK106 - 1035 C/H 100 Model
3		Burner	EK106 - 1163 C/H 140 Model
3		Burner	EK106 - 1036 C/H 200 Model
4		Burner Door Gasket	EK106 - 1091
5		Inlet Pipe	EK106 - 1002
6		Backplate - Back Housing of Boiler	EK106 - 1010
7		Exhaust Pipe	EK106 - 1011

8		Spark Ignitor Inc Bolts	EK106 - 1039
9		Siphon Fittings - Siphon Hose - Gasket & Sealing Nut - Condensation Cup (All in One Sku)	EK106 - 1067
10		Gas Pipe Adapter	EK202 – 1227 C/H 100 Model
			EK202 - 1228 C/H 140 Model
			EK202 - 1343 C/H 200 Model
			EK202 - 1331 C/H 200 Model (Propane)
11		PHE C100 – 12 Plates	EK106 – 1045
		PHE C140/C200 – 18 Plates	EK106-1046
12		Fan Assembly (Includes Fan & Sealing Gasket)	EK106 - 1242

13		Fan Cover -Gas Mixer	EK106 – 1056 C/H 100 Model
			EK106 – 1057 C/H 140 Model
			EK106 – 1058 C/H 200 Model
14		Gas Valve	EK106 - 1040
15		Pump	EK106 - 1259 C/H 100 & C/H 140 Model
			EK106 - 1260 C/H 200 Model
16		Hydroblock	EK106 – 1272 C/H 100 & C/H 140 Model
			EK106 – 1273 C/H 200 Model
17		CH Supply Sensor	EK106 - 0435

17.1		Magnetite Filter	EK106 - 1278 C/H 100 & C/H 140 Model
18		Pressure Sensor	EK106 - 1061
19		Flow Sensor	EK106 - 1062
20		3-Way Valve Motor	EK106 - 1059
21		Display Board	EK106 - 1048
22		Front Housing	
23		Cable Tree Wire for Blue Assembly. 3 way & Supply End Gas Valve Wire	EK05 - 0004

		Pump, Fan & Ground Wire.	
24		Expansion Tank	EK106 - 1069
24.1		Seal Expansion Vessel Connection (O-Ring ½" Unitec 300)	EK106 - 1102
25		Automatic Air Vent (no longer used on boilers made from 2020 or later)	EK106 - 1065
26		Copper Return Pipe	EK106 - 1257
28		Pressure Relief Valve (Watts 374A)	EK106 - 1240
28		D10 Metal Clip (Mounting Clip for Expansion Vessel Connection) (5 Piece)	EK106 - 1098

<p>29</p>		<p>Seal Hydro Connection Adapter (O-Ring 3/4" NBR) Large O-Ring Connects Plate Heat Exchanger to Black Plate</p>	<p>EK106 - 1103</p>
<p>39</p>		<p>Main Board</p>	<p>EK106 - 1243</p>